

# GOVERNANCE TINDER

Beziehungs-Status: kompliziert?

---

Netzwerk Risikomanagement  
Fachveranstaltung  
15.11.2023





# KURZ UND GUT

*wir können risiko*

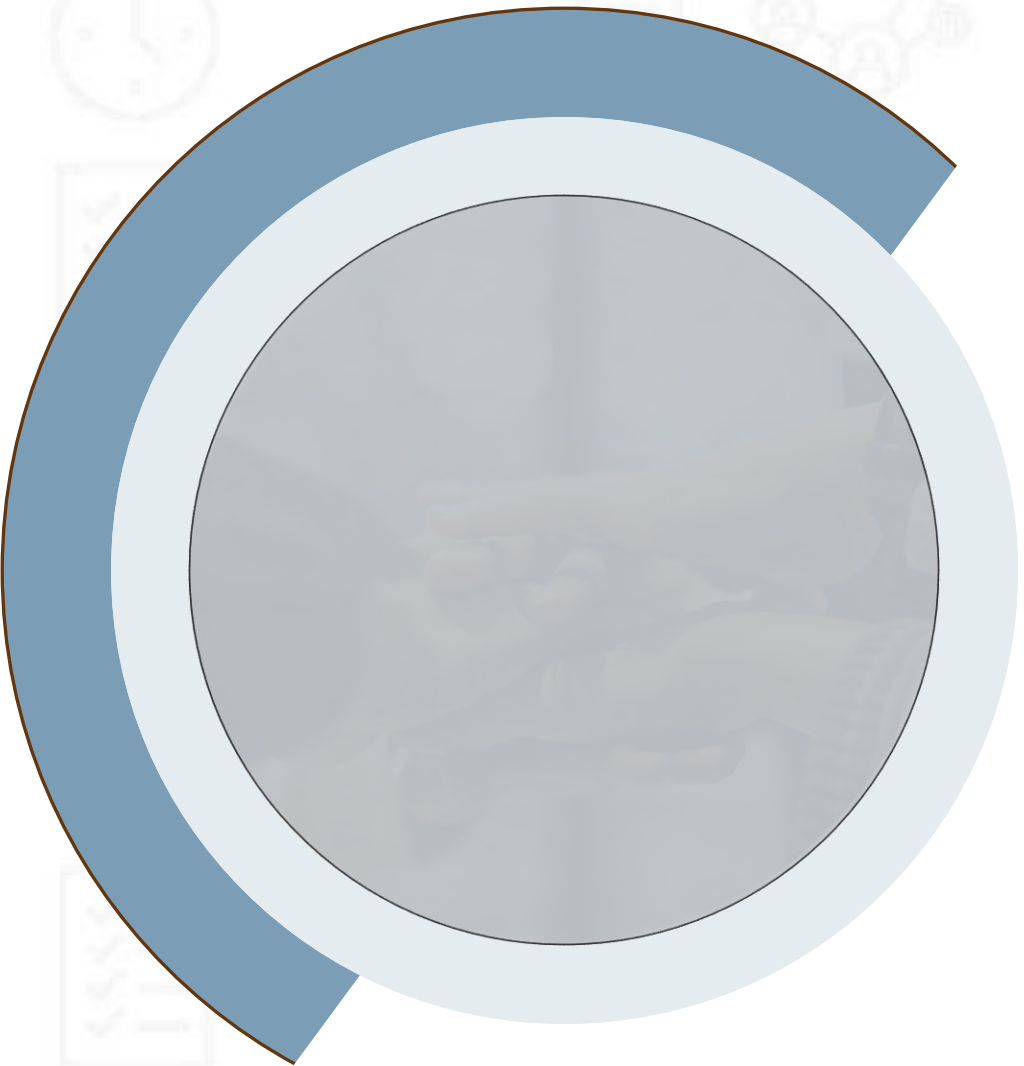

*wir können risiko*

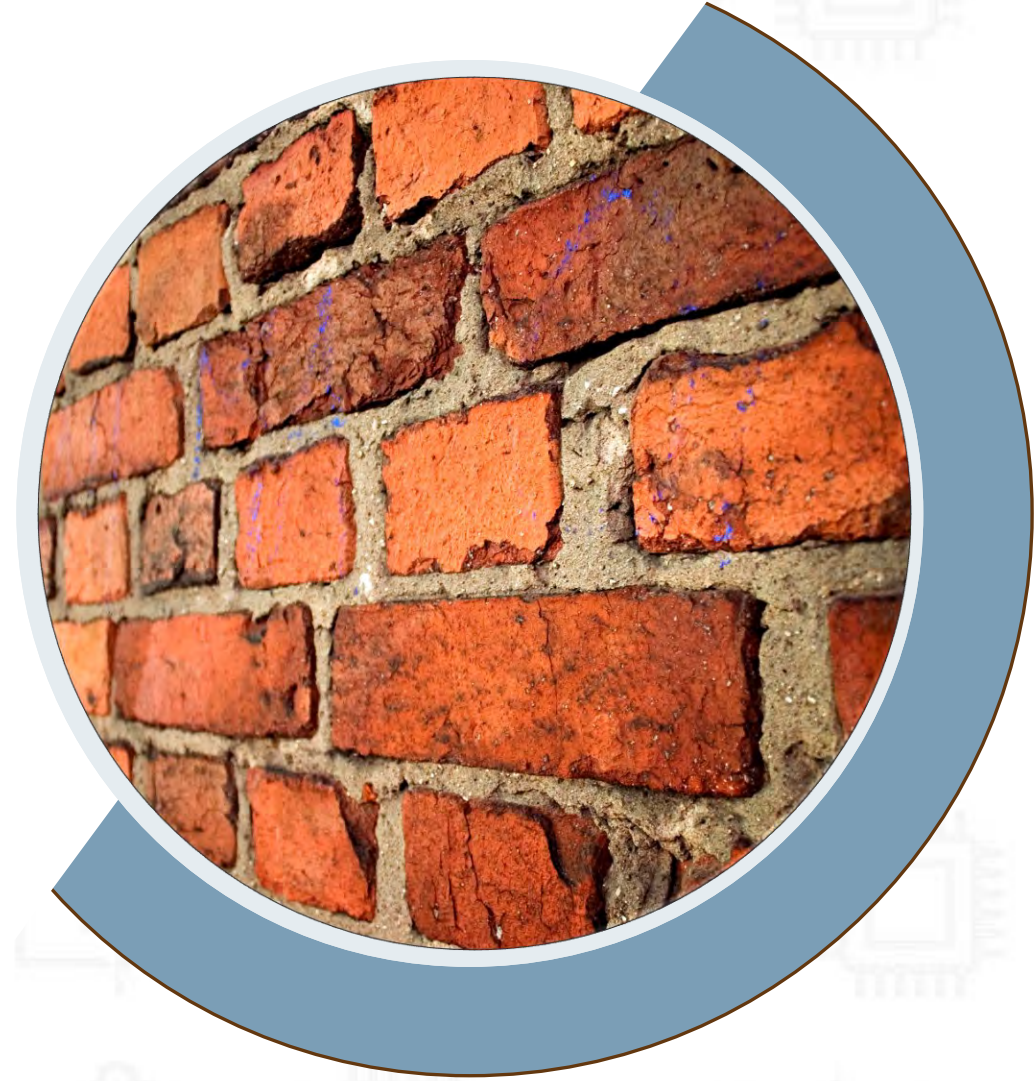
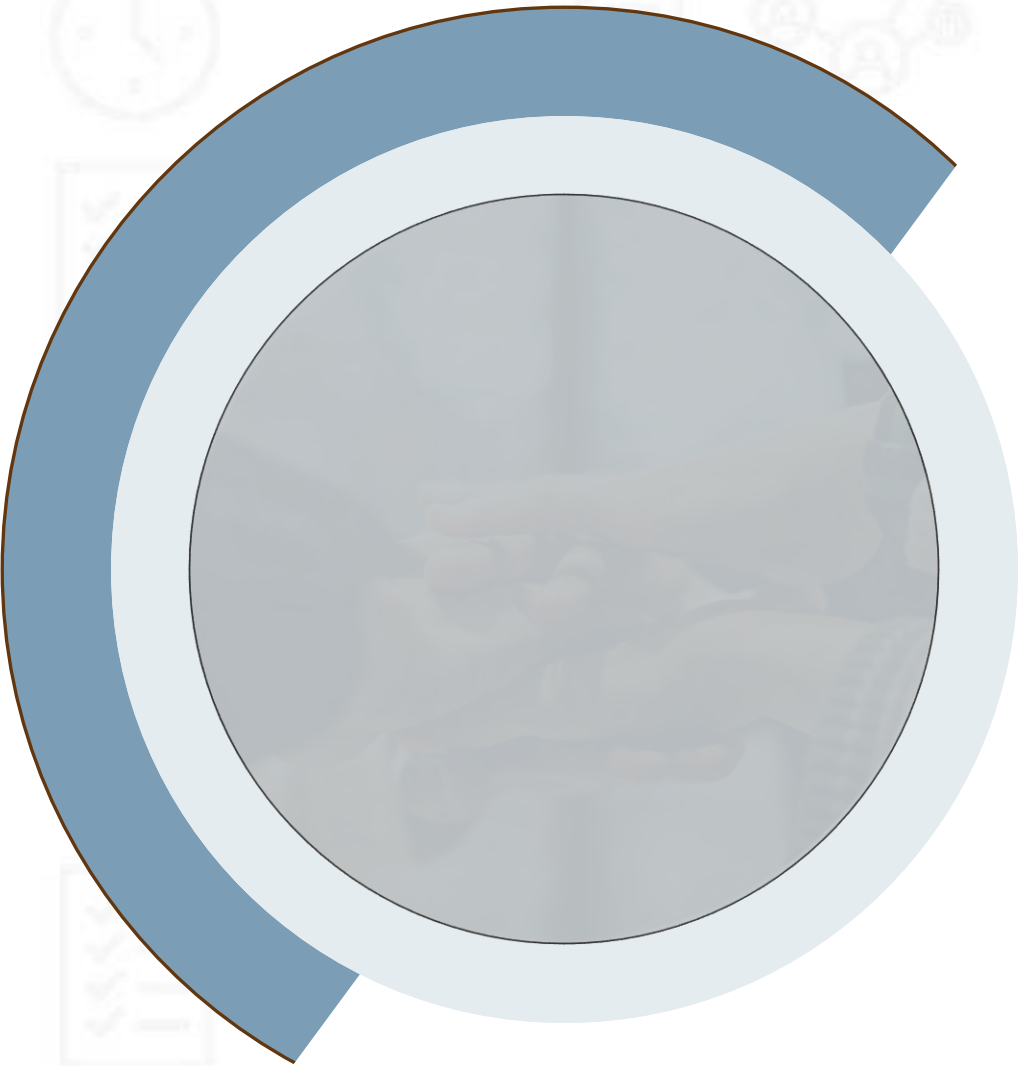

*wir können risiko*

# AGENDA

**01**

***STATUS  
QUO***

# AGENDA

**02**

***SO  
GEHT  
GUT***

# AGENDA

**03**

**150**

**WEGE**

R

# PERSPEKTIVE

N



**WISSEN-  
SCHAFT**



**RÜCK-  
VERS.**



**VR**

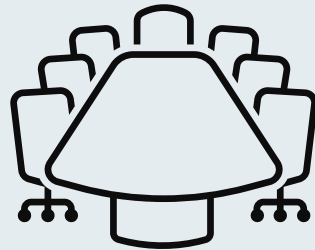

**LEHRE**



**BERATER**



# DER STAND DER DINGE

heir

# VUCA

# VORFALL

# UNREIF

Among our respondents

**65%**

believe the volume and complexity of risks are increasing.

**78%**

of survey respondents note their organization has experienced a significant operational surprise in the last 5 years.

**29%**

of survey respondents describe their organization's risk management oversight as "mature" or "robust".

# ISO 31000:



# ISO 31000:

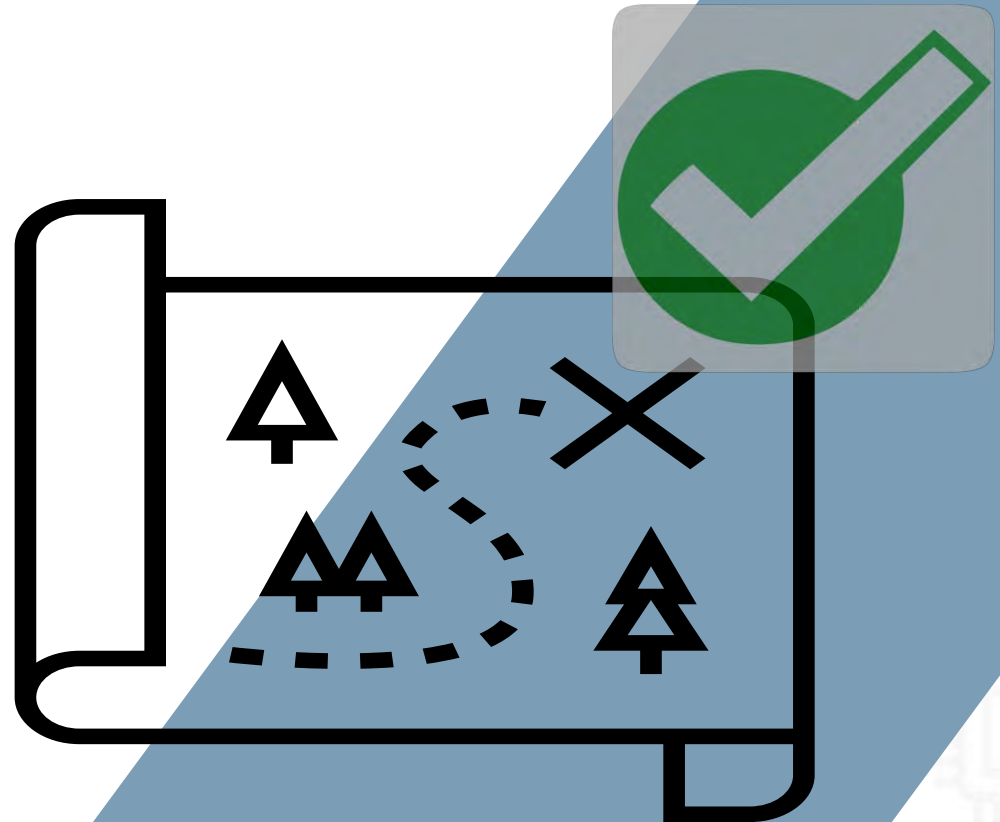
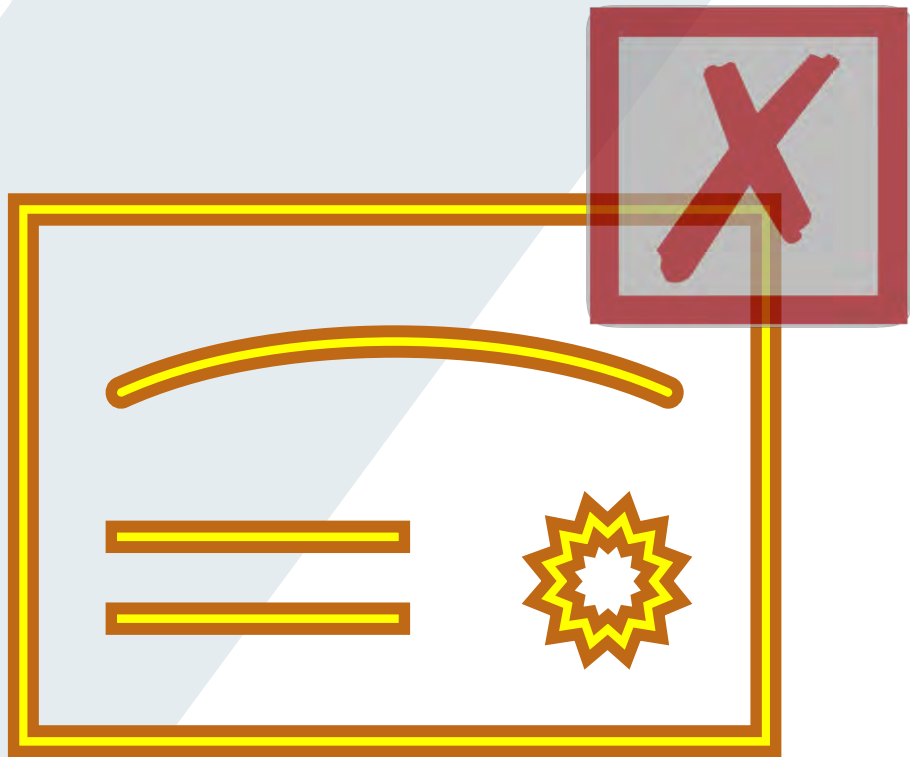

# „SO GEHT GUT“

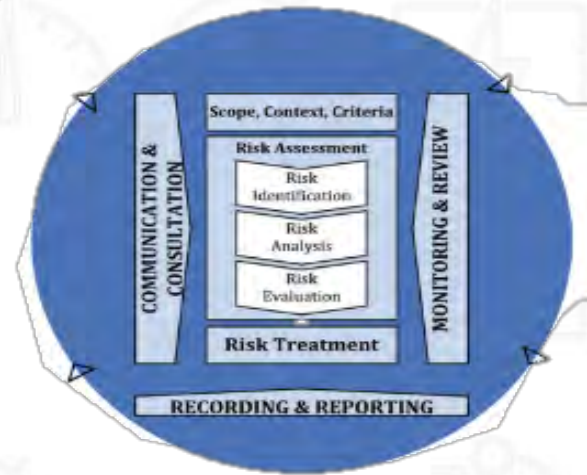

# „PACED“ PRINZIP

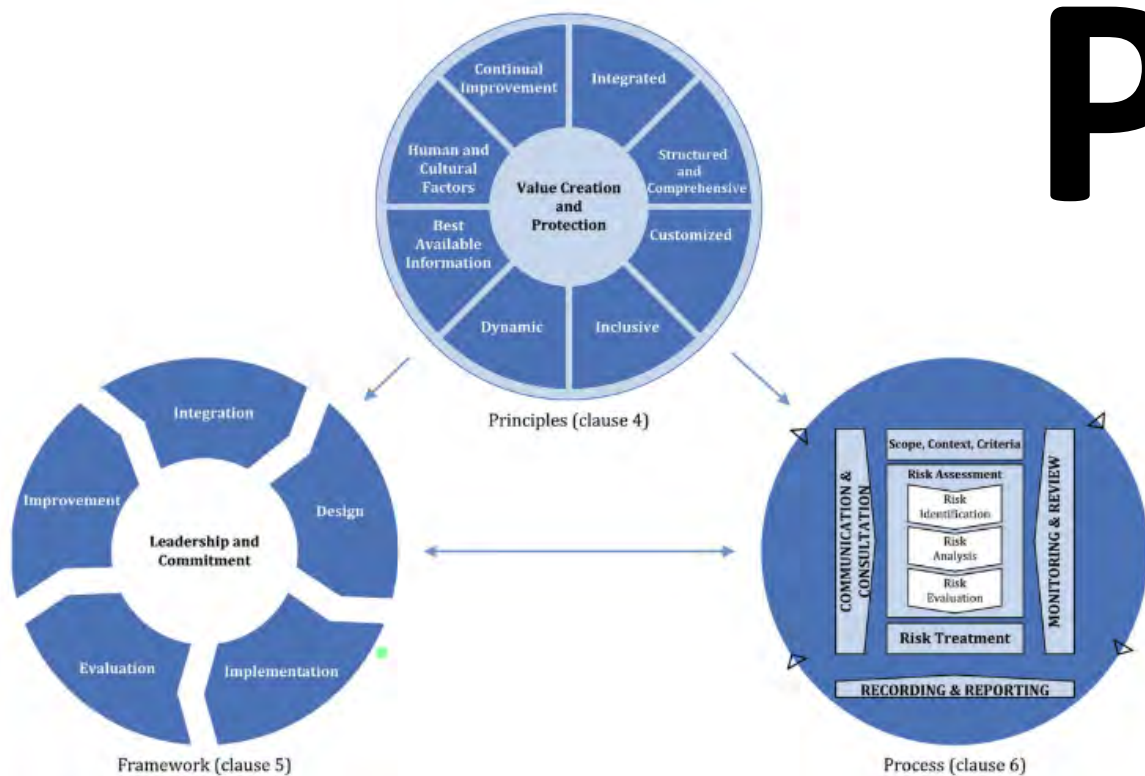
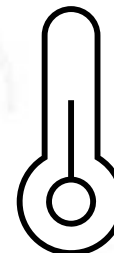

„... **RISIKO** ist, wenn man  
“  
...“

---



**METHODE**



**VOKABULAR**



**KERN-RISIKEN**





# **RISIKO MGMT**

***LIMITE  
GEOGRAPHIE  
BRANCHE***

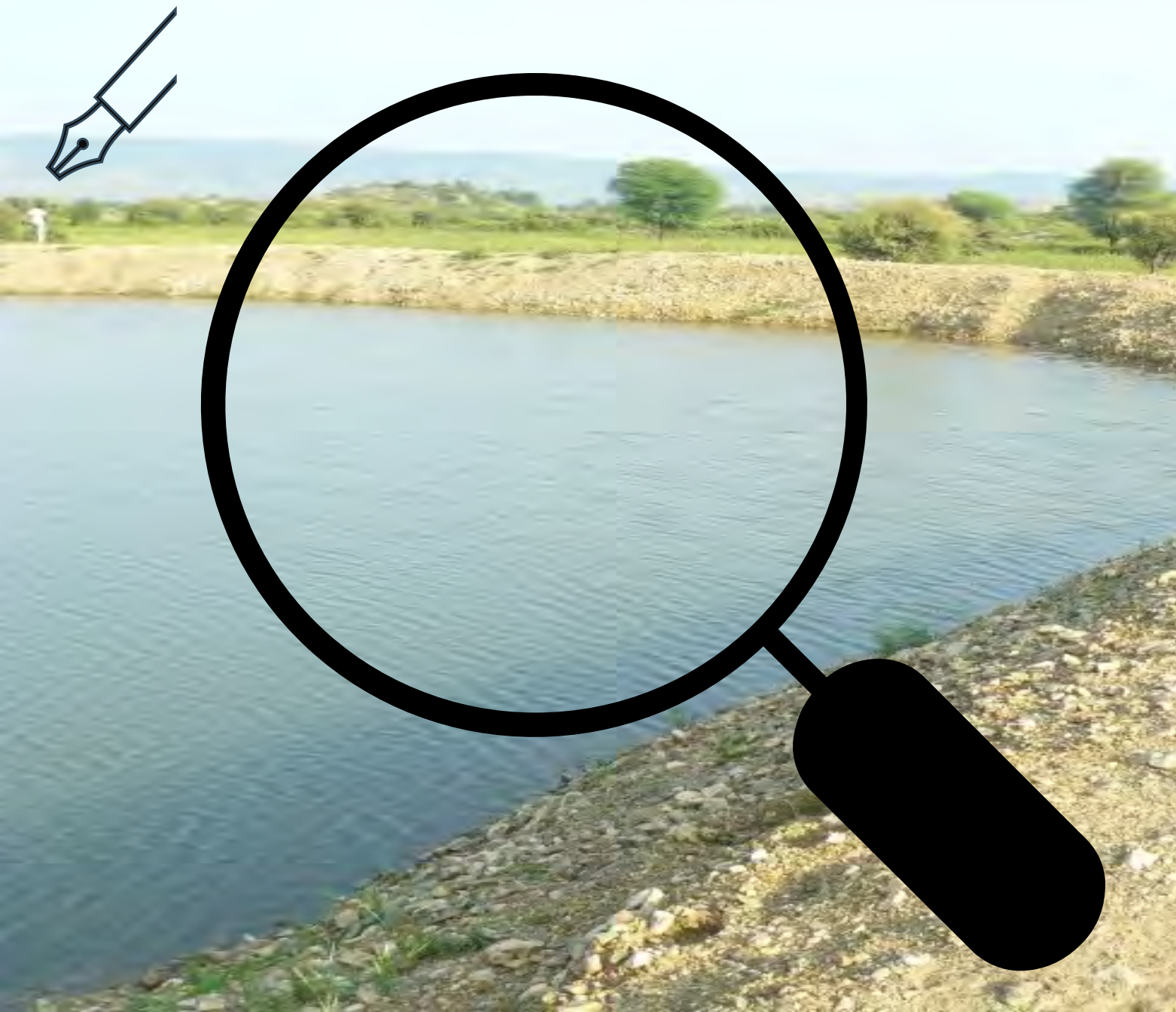

# **RISIKO MGMT**

*LIMITE  
GEOGRAPHIE  
BRANCHE*



cc-by-sa/2.0 - More Hall Reservoir by Dave Pickersgill - [geograph.org.uk/p/2682284](http://geograph.org.uk/p/2682284)

*wir können risiko*



# ZUR DEBATTE

[ IF „IST“

<<

„MAX“ ]

*wir können risiko*

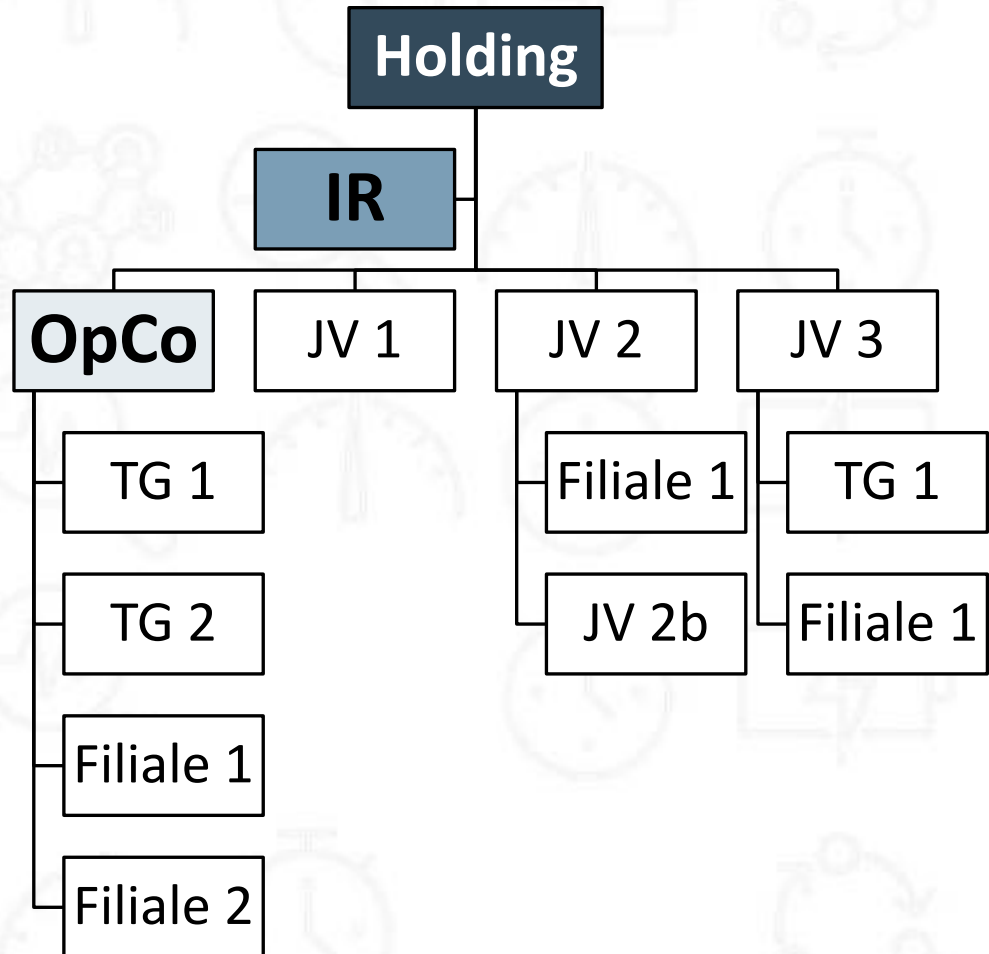
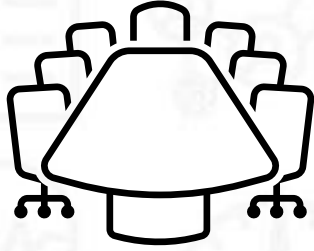
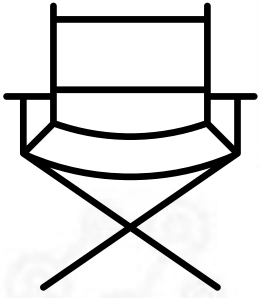

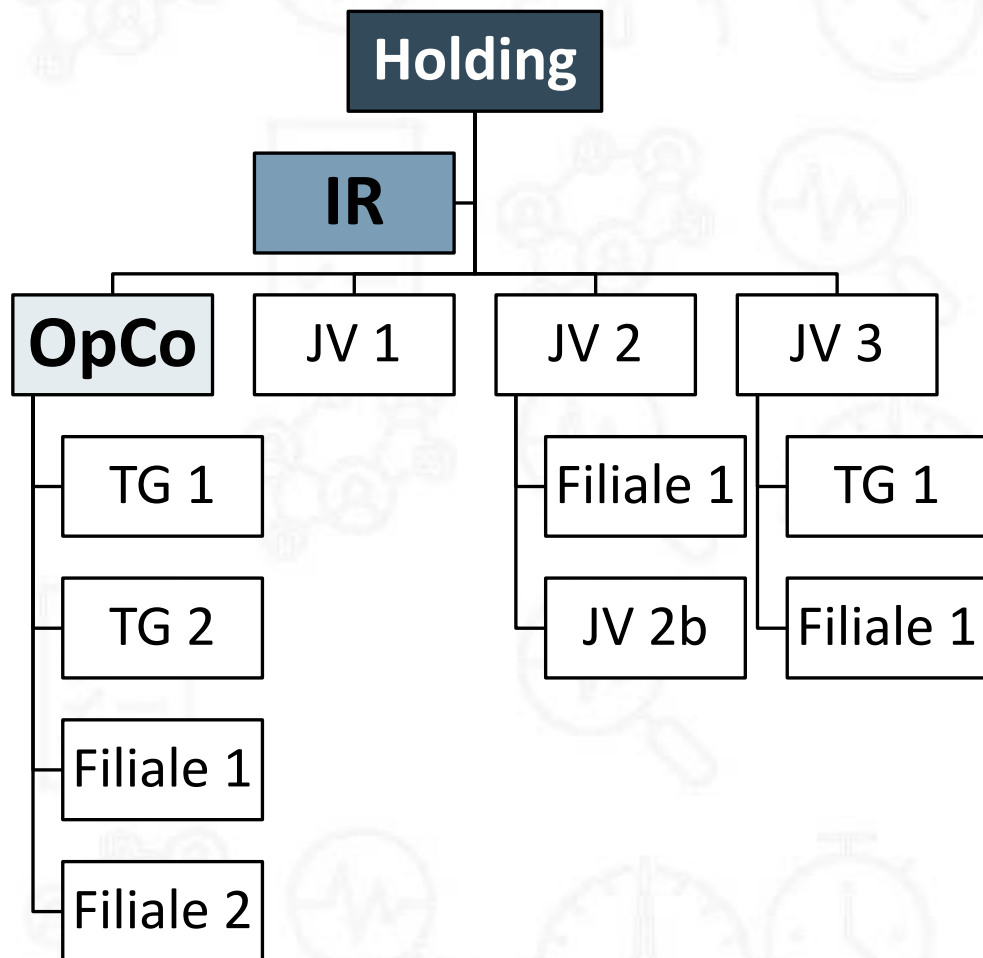
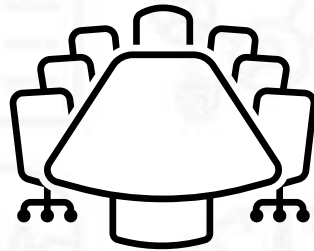
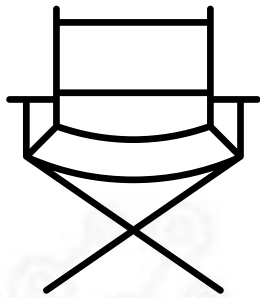

# SCHLÜSSEL-RISIKEN!!

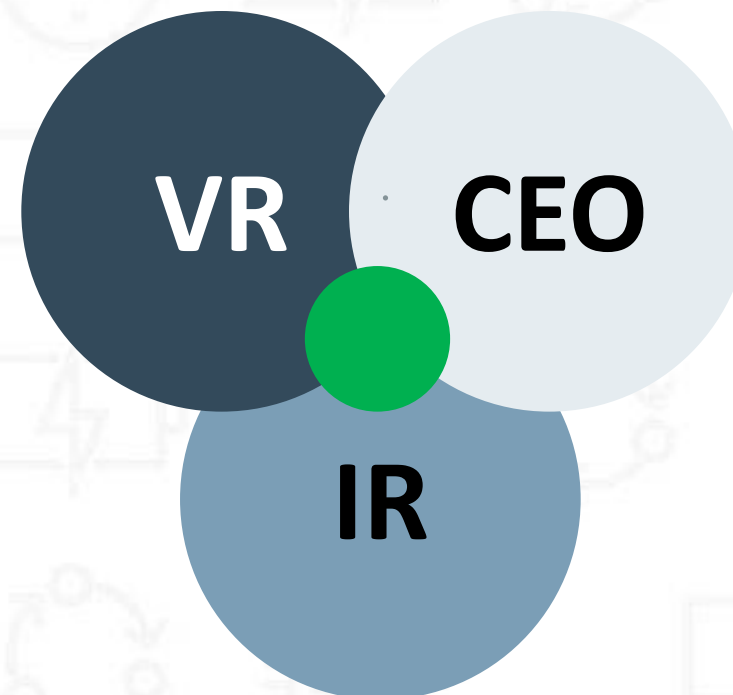

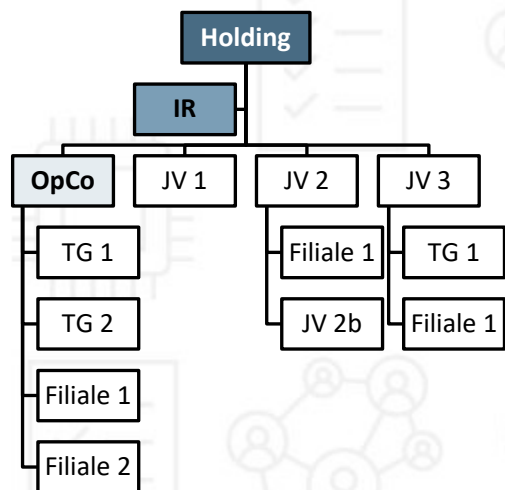
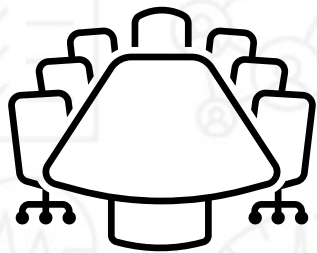
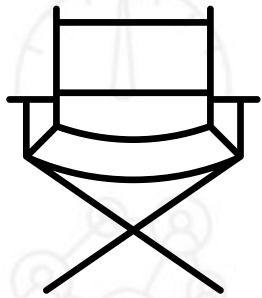

**1, 2, 3,  
4, 5, 6**

**5, 6, 7,  
9, 11, 17, 19, 21**

**1, 2, 7, 9, 11 13**

A construction site at sunset. A crane is lifting a large, dark rectangular concrete slab. The background shows a complex network of steel beams and scaffolding. The sky is a mix of orange, pink, and purple. In the foreground, a worker is visible on a platform.

**Lokale Aufsicht  
International Aufsicht  
Wettbewerb  
„europäisch“**

**Hochschulreife  
Baccalauréat  
Diplome  
„community school“**

**Finanzen  
Risikomgmt  
Leistungsauftrag**





**KERN-  
RISIKEN**

**RISIKO**

**AUSSCHUSS**



**ext.  
REVISIO**

**N**

*wir können risiko*



**ERM**

**BCP**

**BCM**

**ESG**

**???**

**GRC**



**NEU  
HIER**

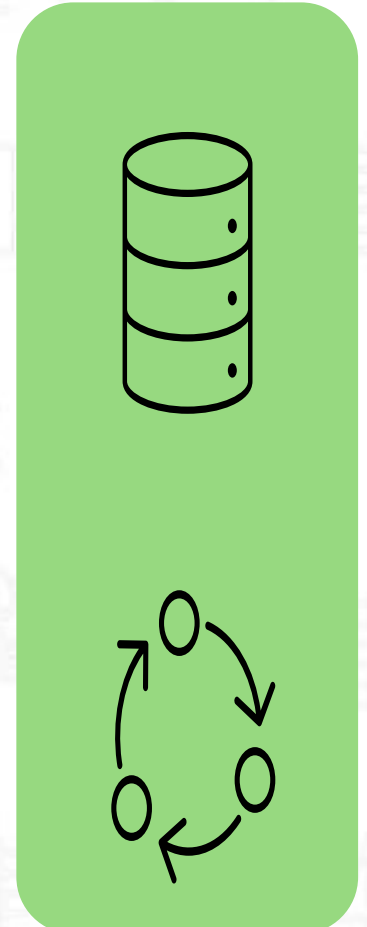
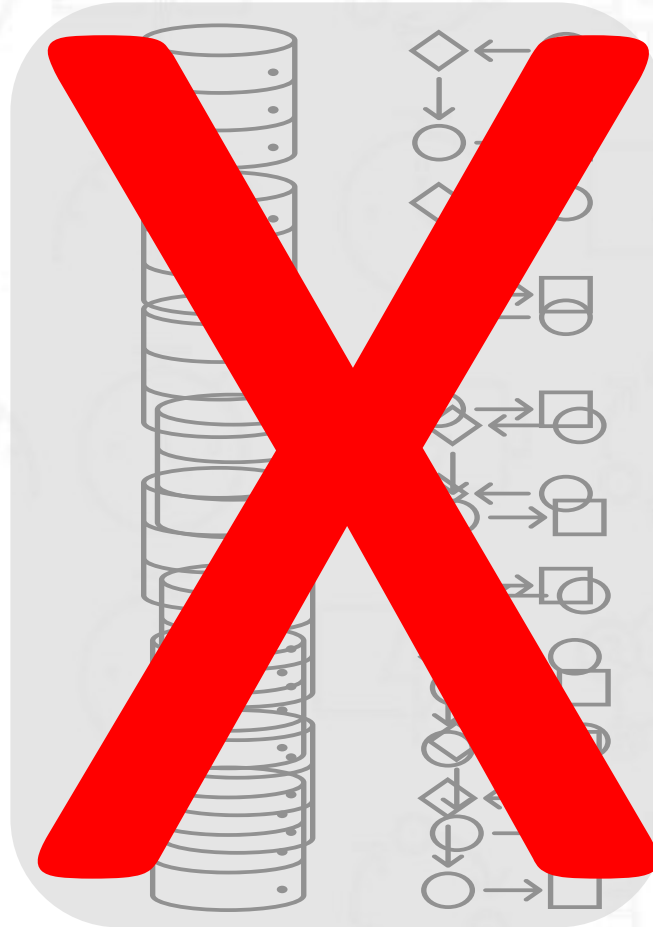
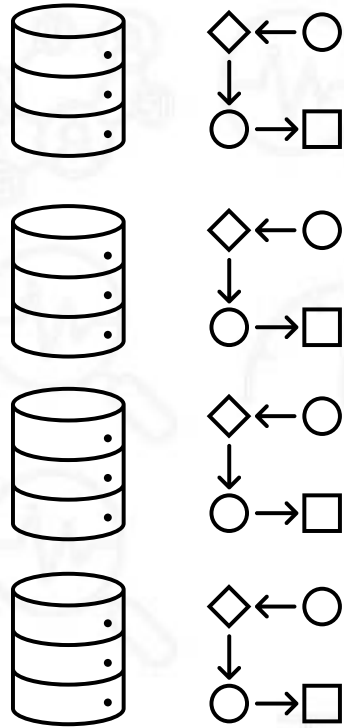
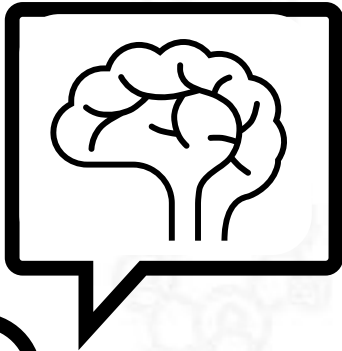



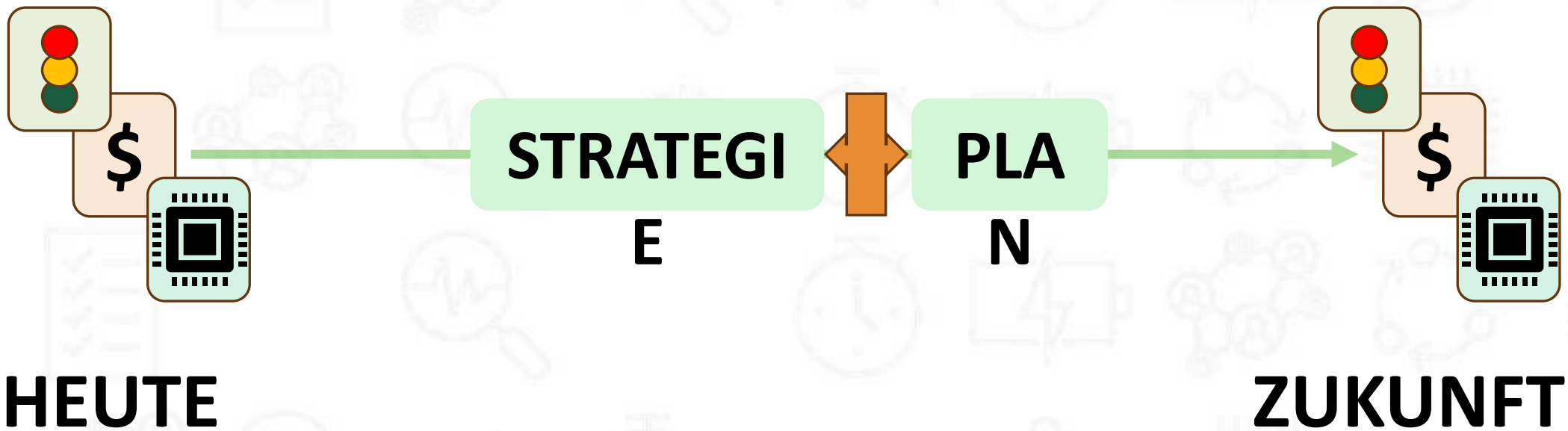

**RM**

**einbinden**



**HEUTE**

**MISSION  
VISION**

**ZUKUNFT**



# KURZ UND GUT

*wir können risiko*

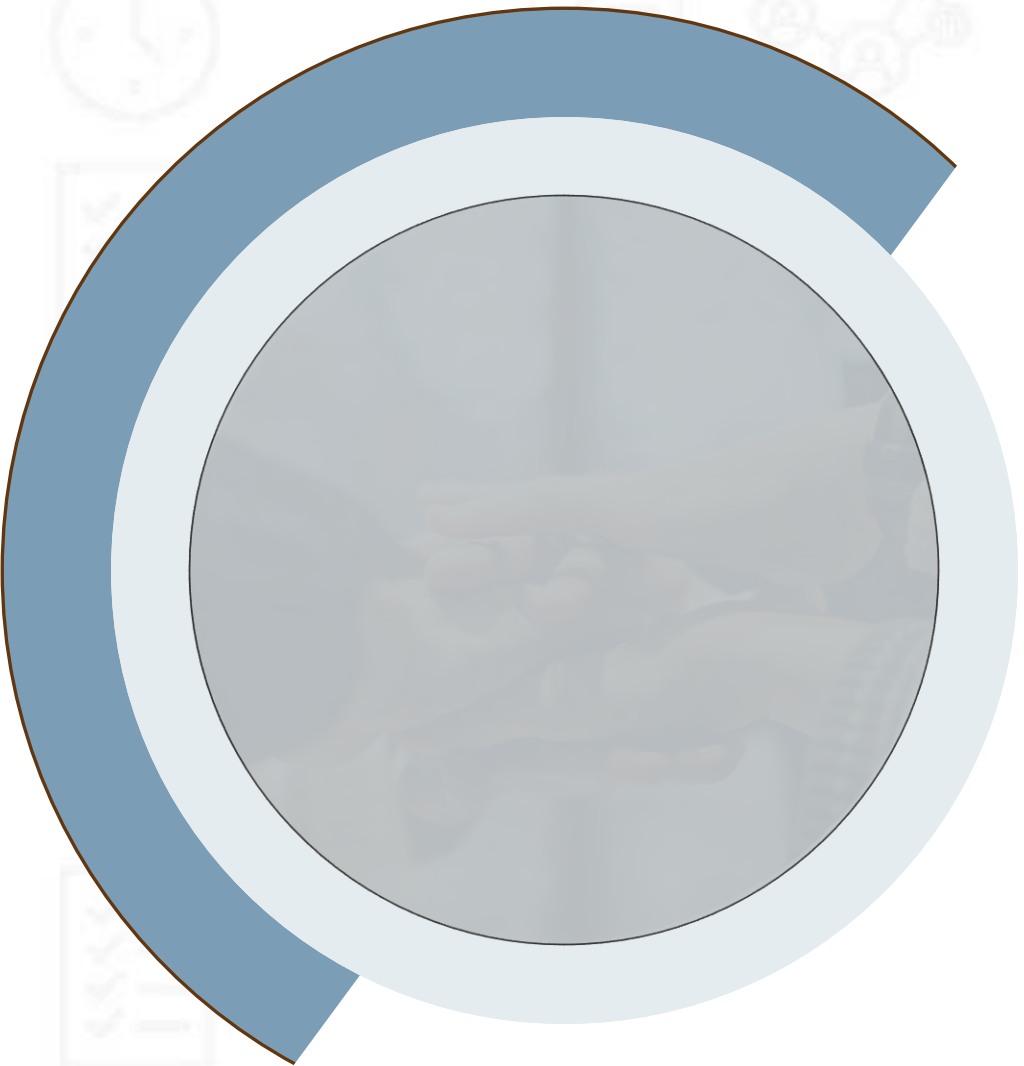

*wir können risiko*



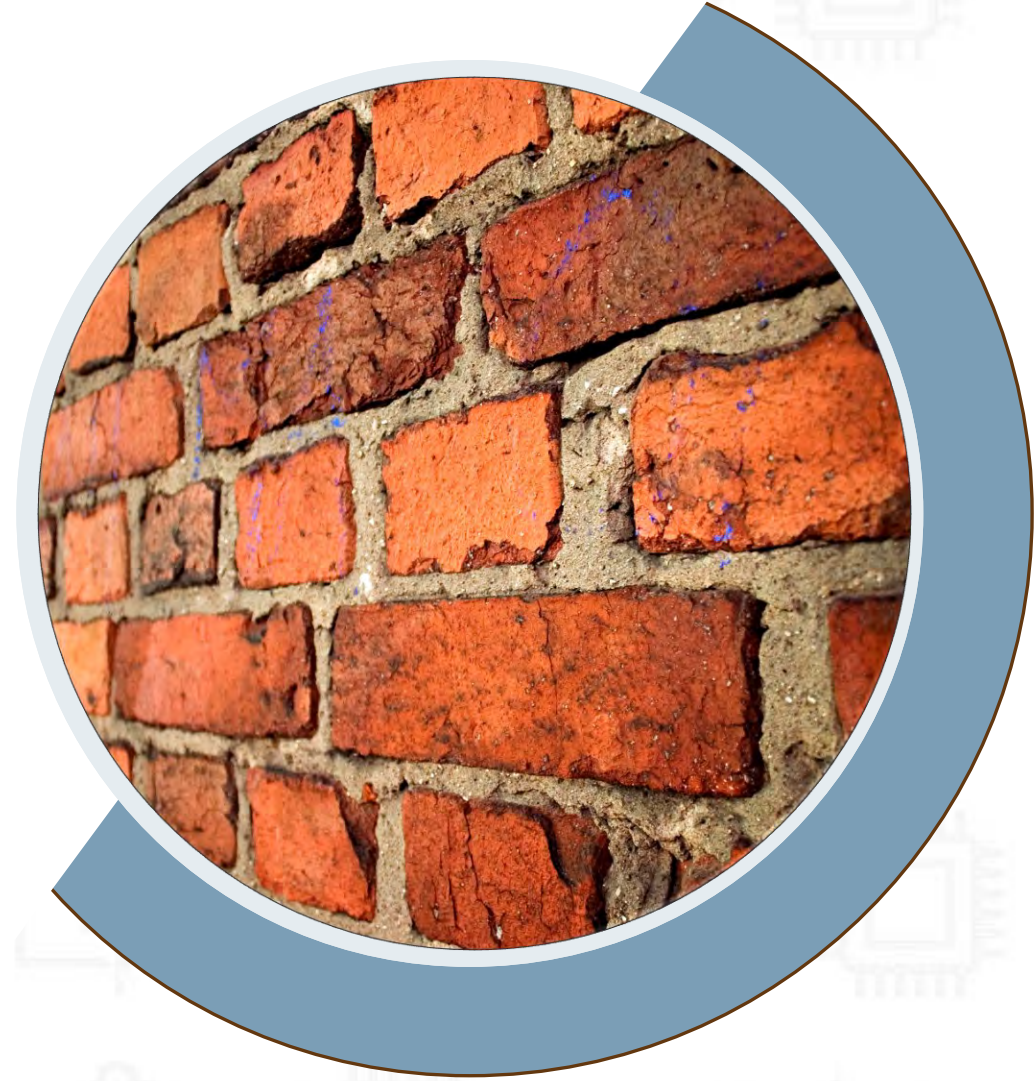
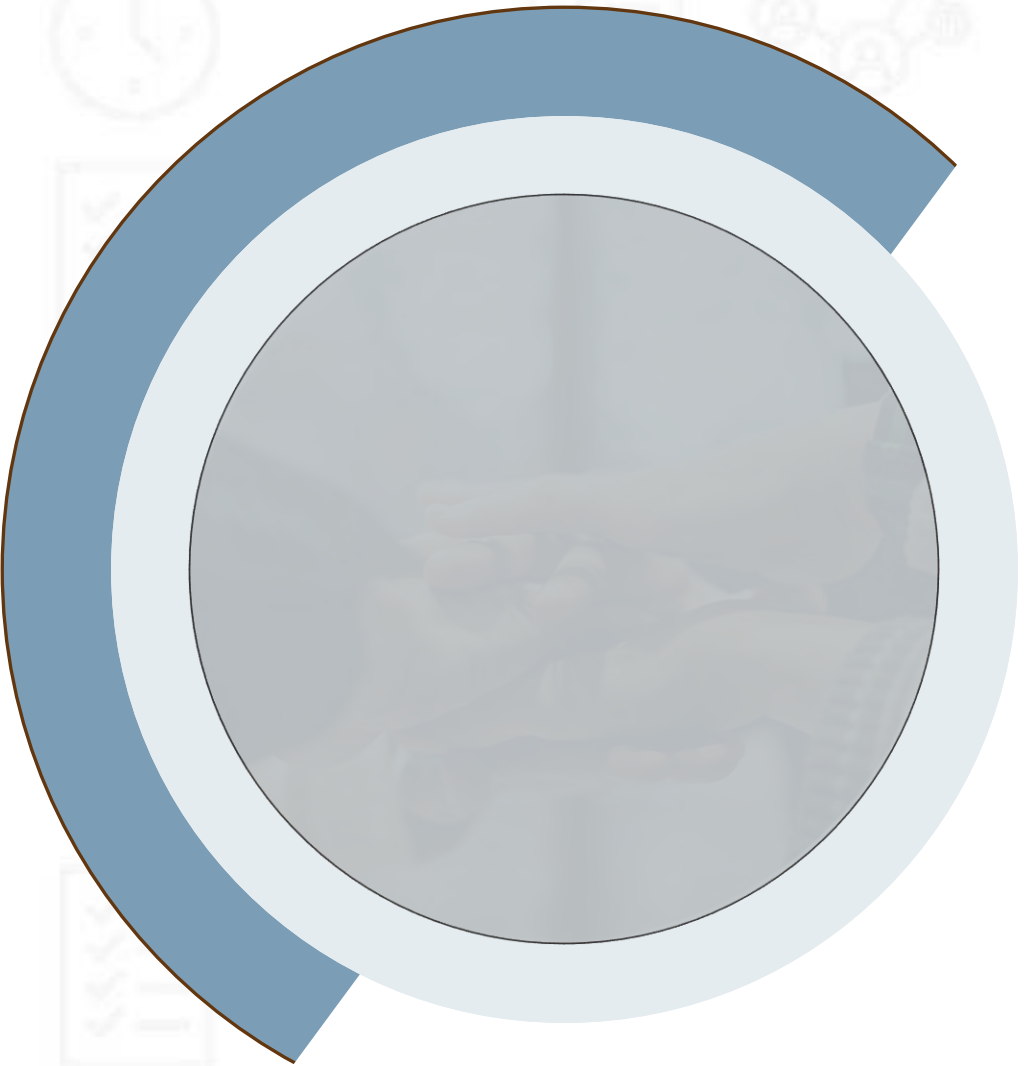

*wir können risiko*

# Danke

---



**YouTube: @Megrow**

**reto.brosi@megrow.asi**

**a**

**[www.megrow.ch](http://www.megrow.ch)**